

 **BILKA**<sup>®</sup>  
• roof system • rain system •



Retro Panel



BILKA

100%

(

)

BILKA

BILKA

2007

140.000

13

BILKA  
337 000

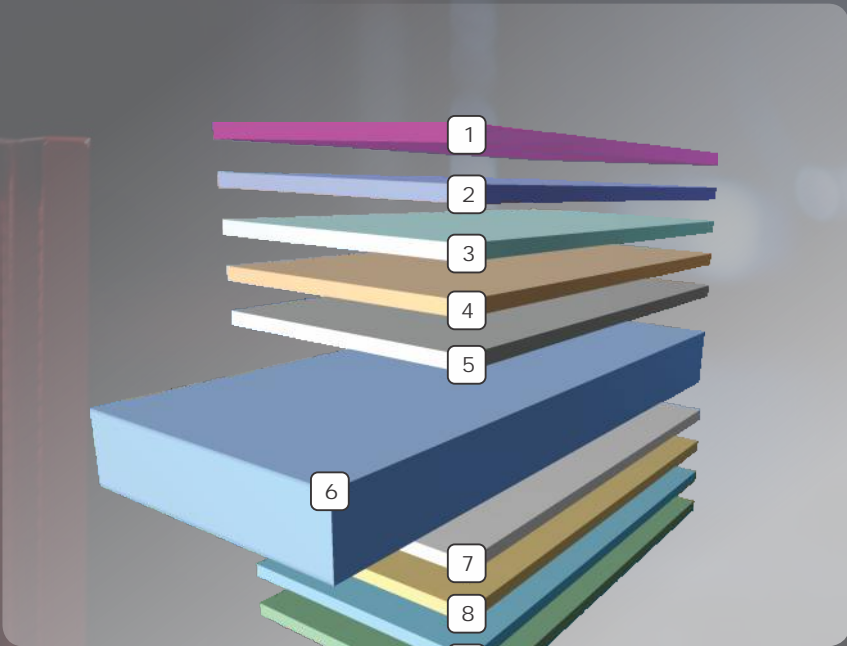
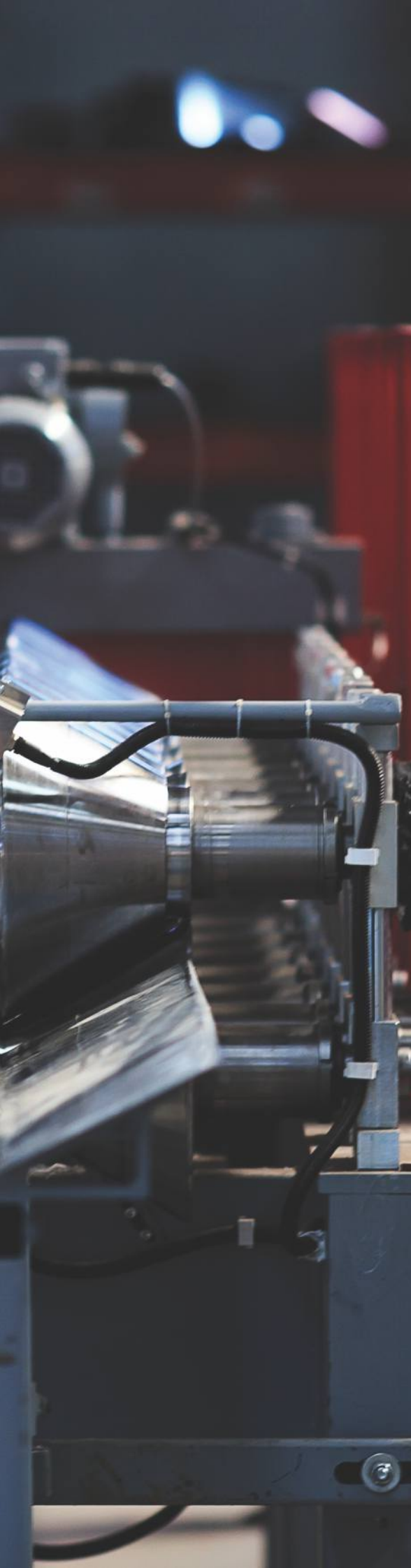

1 - : 50-200  
 2 - ( )  
 3 - : (PE) 35 \* GrandeMat 50  
 4/8 - : (PE) .5  
 5/7 - : 225 - 275 / 2  
 6 - : (PE) .7  
 9 - : ( )  
 10 - ( )  
 \* 200

1 - : 50-200  
 2 - ( )  
 3 - : (PE) 25  
 4/8 - : (PE) .5  
 5/7 - : 225 - 275 / 2  
 6 - : (PE) .7  
 9 - : ( )  
 10 - ( )

# BILKA CLASIC



CLASIC  
(Z 225-Z 275)

0,40-0,60

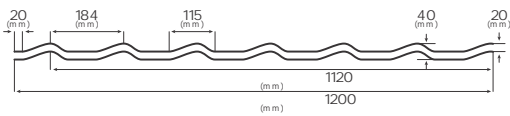

CLASIC

29

500 7000

	0,40 - 0,60
	1200
	1120
	20
	40
	3 - 5 /
	10
	15
GrandeMat	30
	60



GrandeMat



# BILKA BALCANIC



BALCANIC  
(Z 225-Z 275)

0,50-0,60

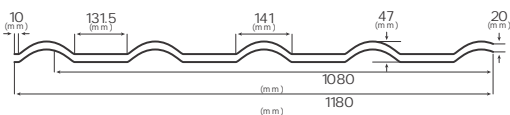

BALCANIC

29

BALCANIC

500 7000

	0,45 - 0,60
	1180
	1080
	20
	47
	4 - 5 /
	10
	15
GrandeMat	30
	60



GrandeMat



# BILKA IBERIC



IBERIC  
(Z 225-Z 275)  
IBERIC

0,50-0,60

500 7000

IBERIC

29

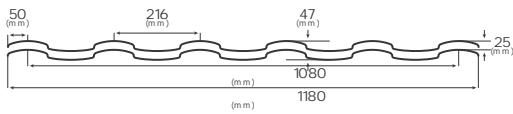

	0,45 - 0,60
	1180
	1080
	25
	47
	4 - 5 / .
	10
	15
GrandeMat	30
	60



RAL 3000 RAL 3005 RAL 3009 RAL 3011 RAL 5010 RAL 6005 RAL 7024

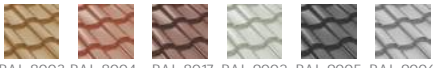

RAL 8003 RAL 8004 RAL 8017 RAL 9002 RAL 9005 RAL 9006

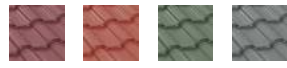

RAL 3005 RAL 3009 RAL 6020 RAL 7024

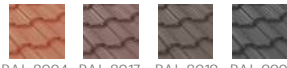

RAL 8004 RAL 8017 RAL 8019 RAL 9005 black

## GrandeMat

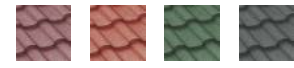

RAL 3005 RAL 3011 RAL 6005 RAL 7024  
GrandeMat GrandeMat GrandeMat GrandeMat

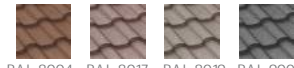

RAL 8004 RAL 8017 RAL 8019 RAL 9005  
GrandeMat GrandeMat GrandeMat GrandeMat

# BILKA GOTIC



GOTIC  
(Z 225-Z 275)  
GOTIC

0,50-0,60

500 7000

GOTIC

25

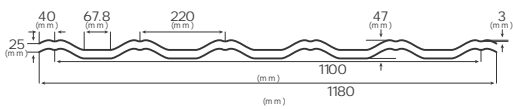

	0,45 - 0,60
	1180
	1100
	25
	47
	4 - 5 / .
	10
	15
GrandeMat	30
	60

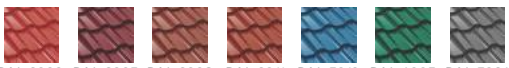

RAL 3000 RAL 3005 RAL 3009 RAL 3011 RAL 5010 RAL 6005 RAL 7024

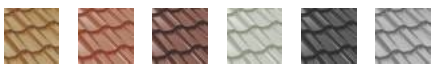

RAL 8003 RAL 8004 RAL 8017 RAL 9002 RAL 9005 RAL 9006

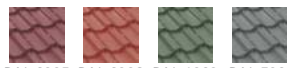

RAL 3005 RAL 3009 RAL 6020 RAL 7024



RAL 8004 RAL 8017 RAL 8019 RAL 9005 black

## GrandeMat

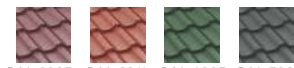

RAL 3005 RAL 3011 RAL 6005 RAL 7024  
GrandeMat GrandeMat GrandeMat GrandeMat

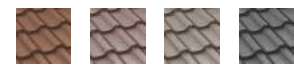

RAL 8004 RAL 8017 RAL 8019 RAL 9005  
GrandeMat GrandeMat GrandeMat GrandeMat

# BILKA ROMANIC

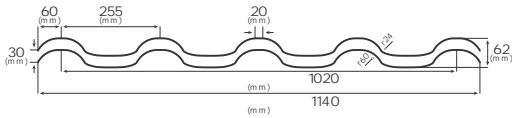

ROMANIC (Z 225-Z 275) 0,50-0,60 ROMANIC  
 500 7000  
 ROMANIC 29  
 30

	0,50 - 0,60
	1140
	1020
	30
	62
	4 - 5 /
	10
	15
GrandeMat	30
	60



# BILKA RETRO PANEL

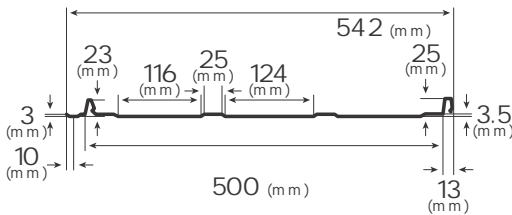

	0,45 - 0,60
	542
	500
	25
	4 - 5 /
	10
	15
GrandeMat	30
	60



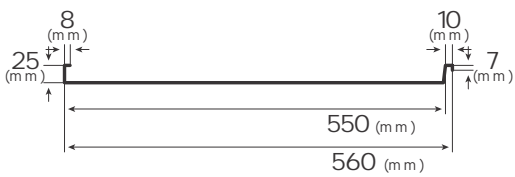

BILKA

0,45-0,6

}

12 BILKA  
SSAB.

BILKA.  
PLX

3

}

29

DX51,

	0,45 - 0,60
	560
	550
	25
	4 - 7 / .
	10
	15
GrandeMat	30
SSAB	30
	15
60-year lifespan, resistance to temperature changes	

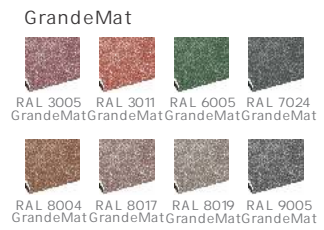

BILKA,



8

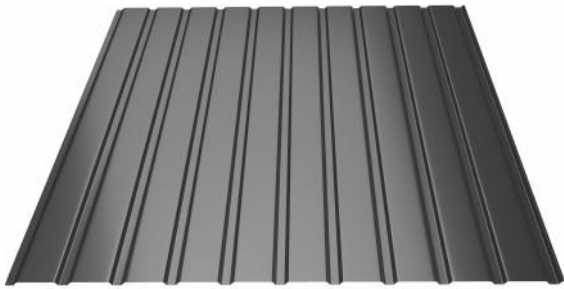

T8 ( )

BILKA T8

0,3-0,6

0,500 135

BILKA

31

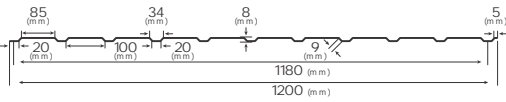

	0,30	- 0,60
	1200	
	1180	
	8	
	2 - 7	/
	10	
	15	
	Wood	15
	GrandeMat	30
		60

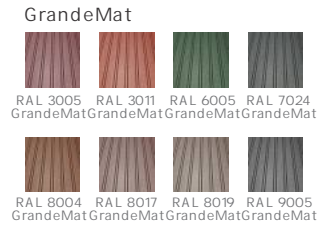

12



T12 ( )

BILKA T12

0,3 - 0,7  
0,500

13,5

BILKA

1000

1250

31

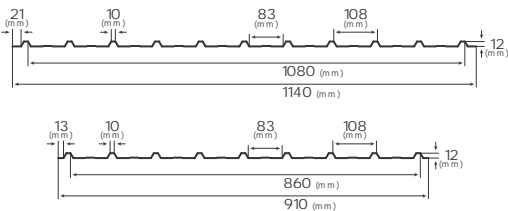

	0,30	- 0,70
	1140	/ 910
	1080	/ 860
	12	
	2 - 7	/
	10	
	15	
	Wood	15
	GrandeMat	30
		60



BILKA

# S18 SINUS

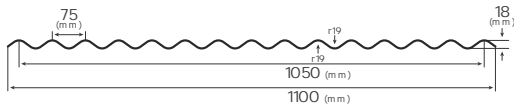

S18 Sinus

( )

S18

BILKA S18

0,4-0,7

0,500 13,5

BILKA.

31

	0,40 - 0,70
	1100
	1050
	18
	3 - 7 / .
	10
	15
Wood	15
GrandeMat	30
	60



GrandeMat



Wood



# 18

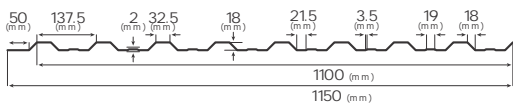
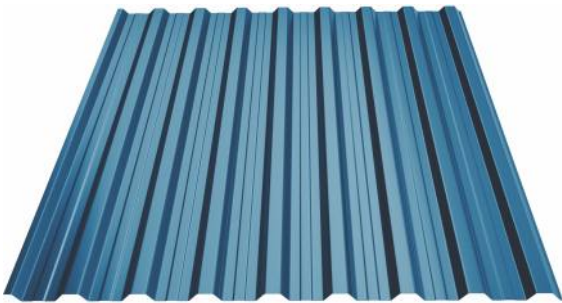

T18

( )

BILKA T18

0,4 - 0,7  
0,500 13,5

BILKA.

31

	0,40 - 0,70
	1150
	1100
	18
	2 - 7 / .
	10
	15
Wood	15
GrandeMat	30
	60



GrandeMat



Wood



BILKA.

# 35

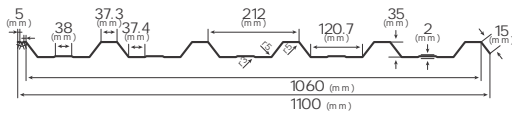

T35 BILKA

BILKA

D RIPSTOP,

BILKA T35

T35

0,4 - 10  
0,500 13,5

BILKA.

31

	0,40 - 100
	1100
	1060
	35
	3 - 12,5 /
	10
	15
Wood	15
GrandeMat	30
	60

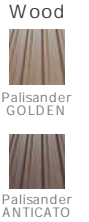

# 45

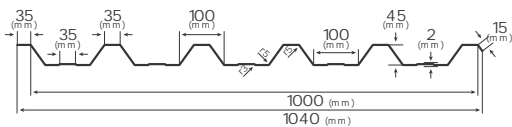
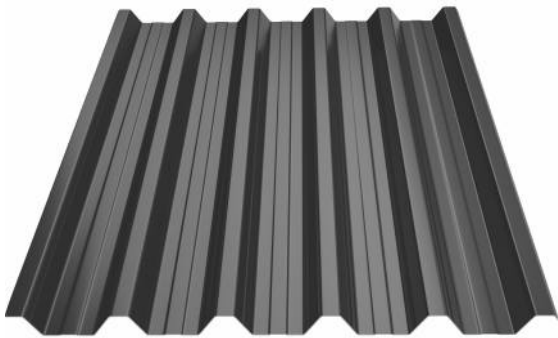

T45

BILKA T45

0,4-1

0,500 13,5

BILKA.

31

	0,40 - 100
	1040
	1000 ± 5
	45
	3 - 12,5 /
	10
	15
Wood	15
GrandeMat	30
	60

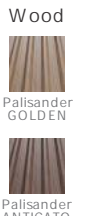

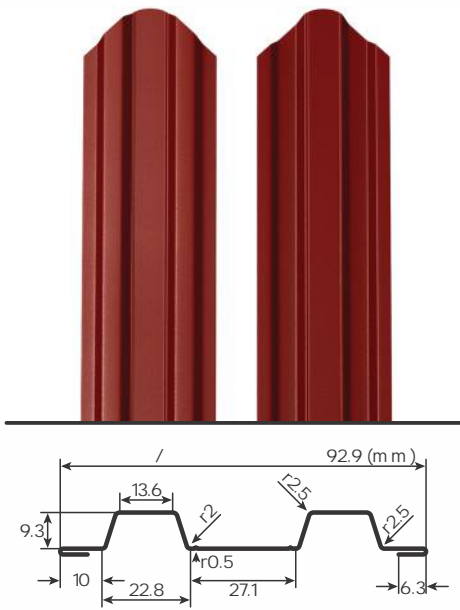

( ) BILKA  
 BILKA  
 BILKA,  
 60  
 ( )  
 ( )

	0,40 - 0,60	SSAB 0,60	Aluzinc 0,50 mm - 0,60
/	92,9		
	9,3		
	1,25 m   1,50 m   1,75 m   2,00		
	10		
	15		
Wood	15		
GrandeMat	30		
SSAB	30	15	
Aluzinc	25		
	60		



# WOOD by BILKA®

WOOD -

BILKA,

WOOD -

WOOD

WOOD



Palisander  
GOLDEN



Palisander  
ANTICATO

	0,45
	35
	225 g / m <sup>2</sup>
	RC3
	RUV4
	5 / 2
	15
	60



# GrandeMat by BILKA®

GrandeMat

GrandeMat

GrandeMat CLASIC, BALKANIC, GOTIC, IBERIC, ROMANIC } GrandeMat 8 RETRO PANEL.

GrandeMat

GrandeMat



RAL 3005  
GrandeMat



RAL 3011  
GrandeMat



RAL 6005  
GrandeMat



RAL 7024  
GrandeMat



RAL 8004  
GrandeMat



RAL 8017  
GrandeMat



RAL 8019  
GrandeMat



RAL 9005  
GrandeMat

	0,50
	50
	275 g / m <sup>2</sup>
	RC4
	RUV4
	5 / 2
	30
	60





BILKA

BILKA

0,6  
(2x35)

(275 / . .)

BILKA



1	2	3	4	5
	C			

		-
	35 / 35	ISO 2808
	6	EN 10169-1
	40	EN 13523-2
	0.5 x t	EN 13523-7
	- 15°C	-
	35N	EN 13523-5
	+ 100°C	-
	RUV3	prEN 10169-2
	RC5	prEN 10169-2
	275 / 2	-

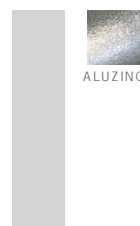

125/90

BILKA  
13

- 150/100

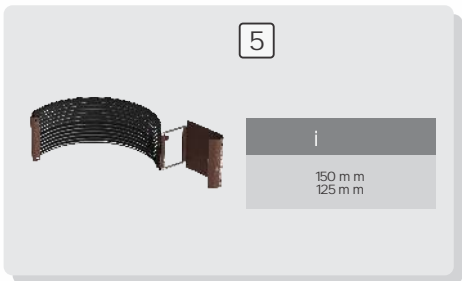
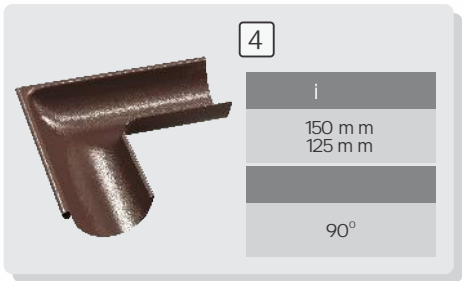
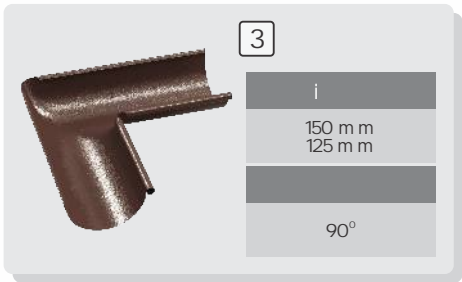
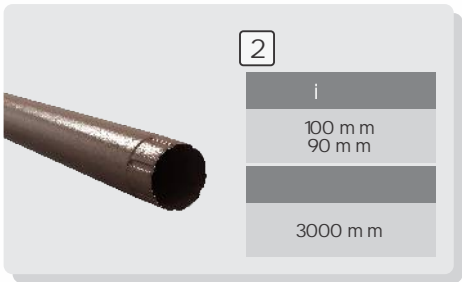
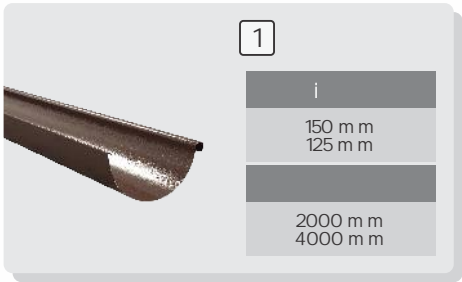
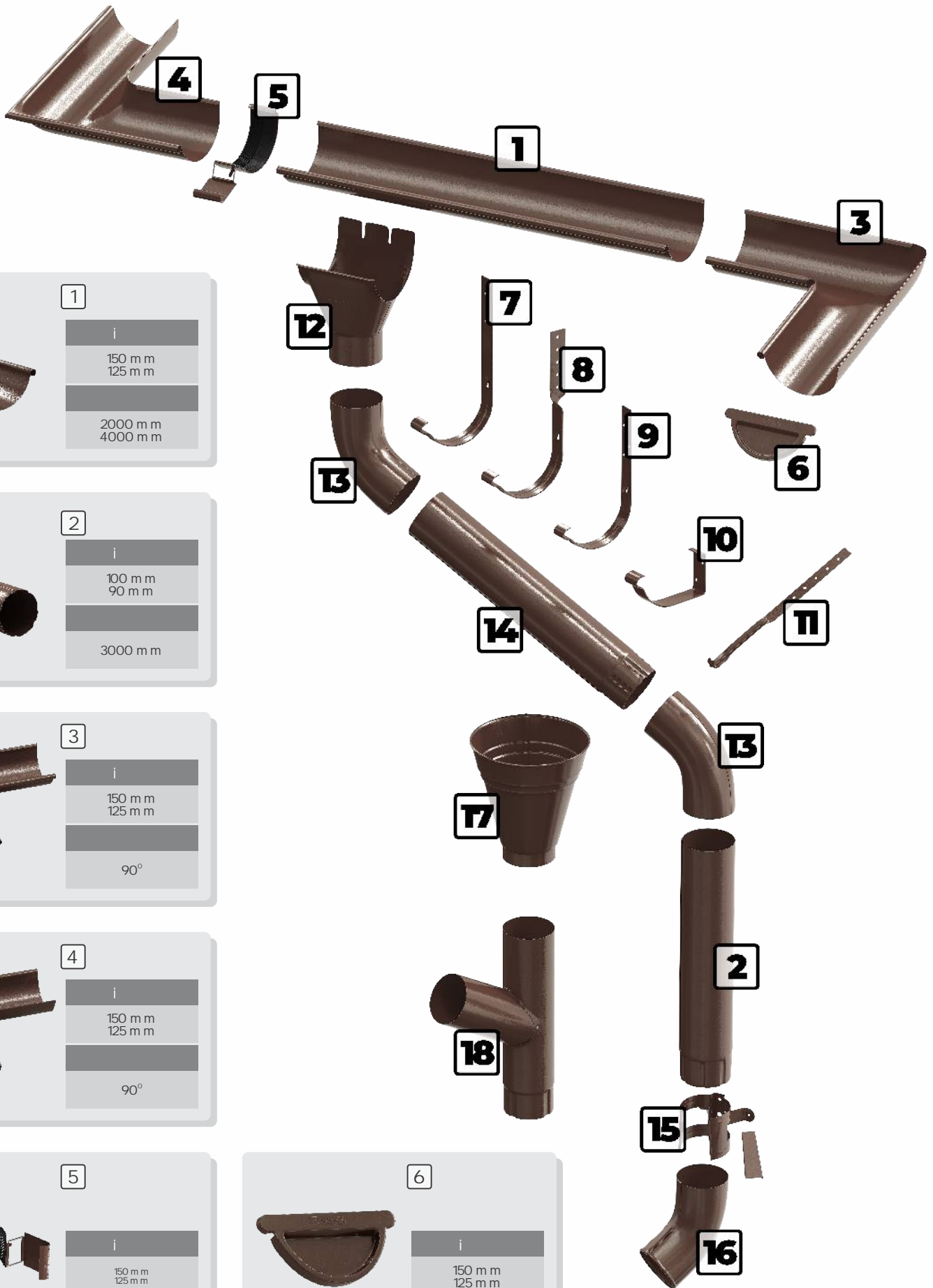

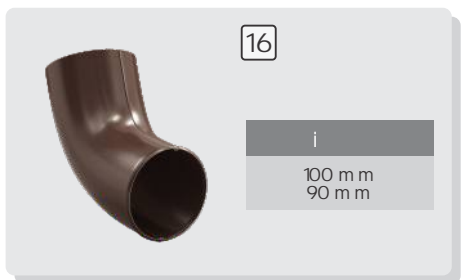
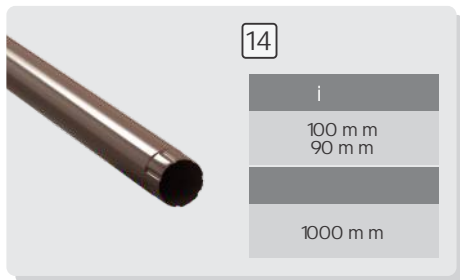
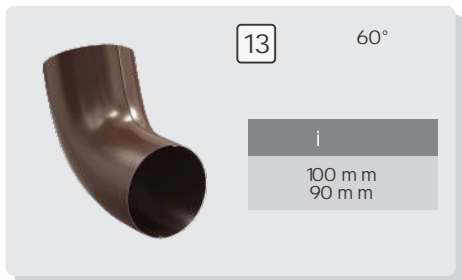
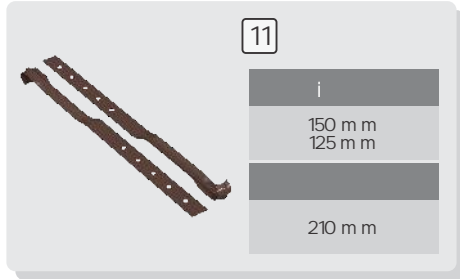
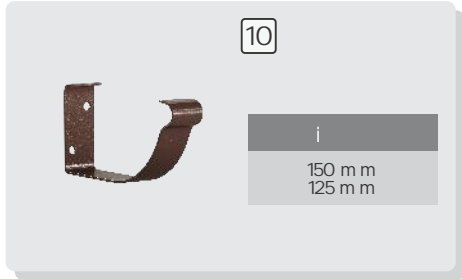
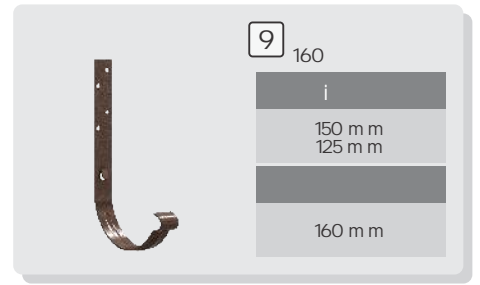
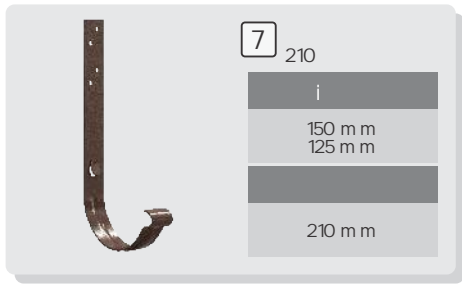

BILKA

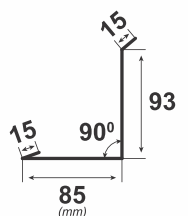
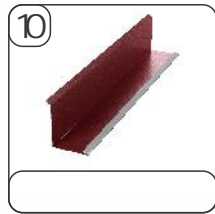
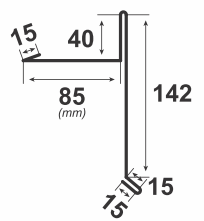
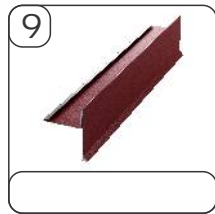
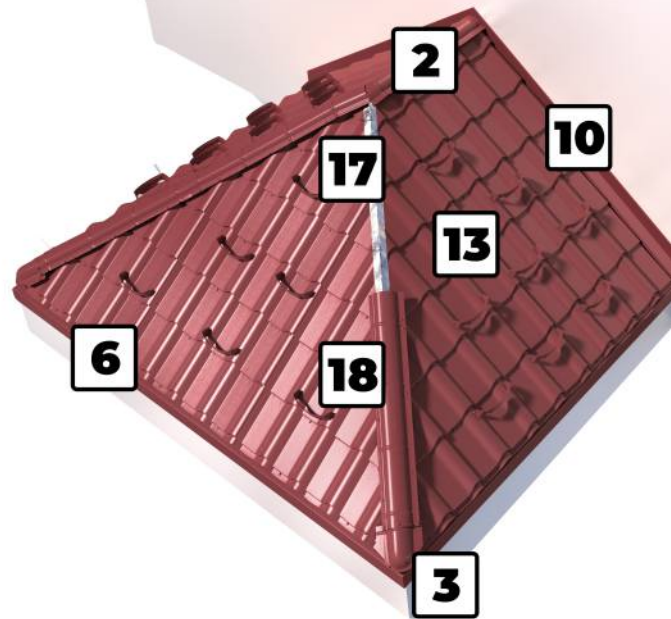
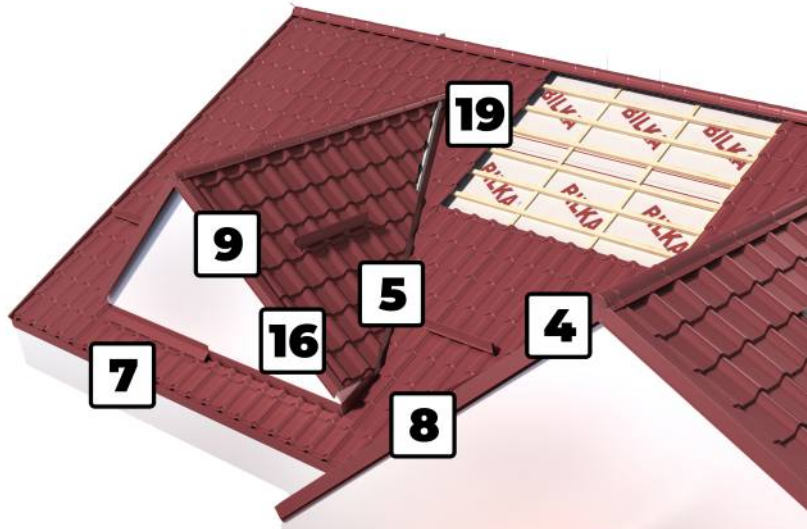
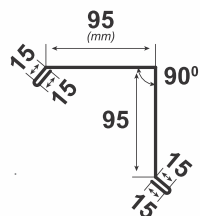
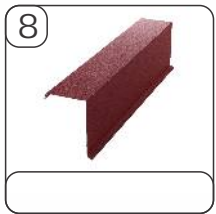
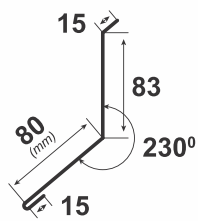
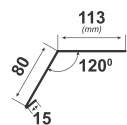
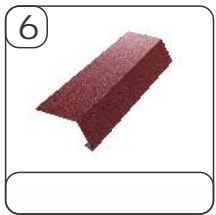
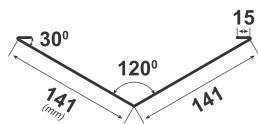
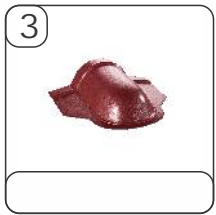
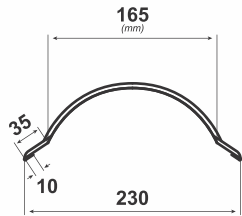
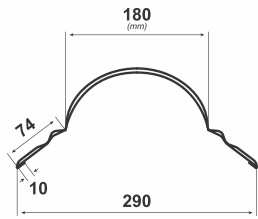

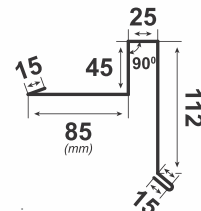
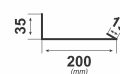
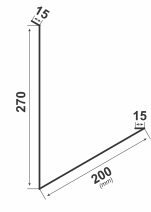
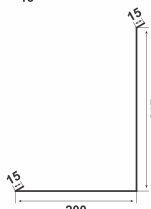
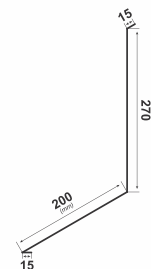
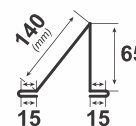
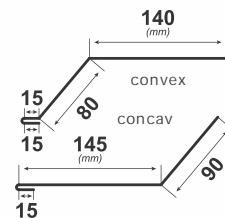
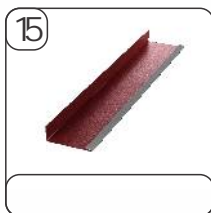
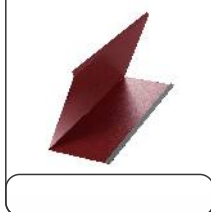
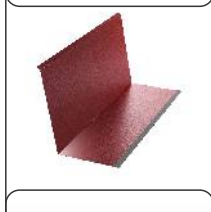
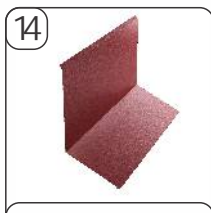
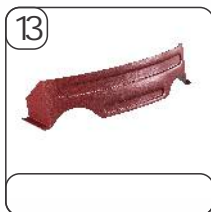
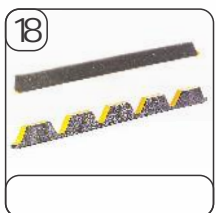
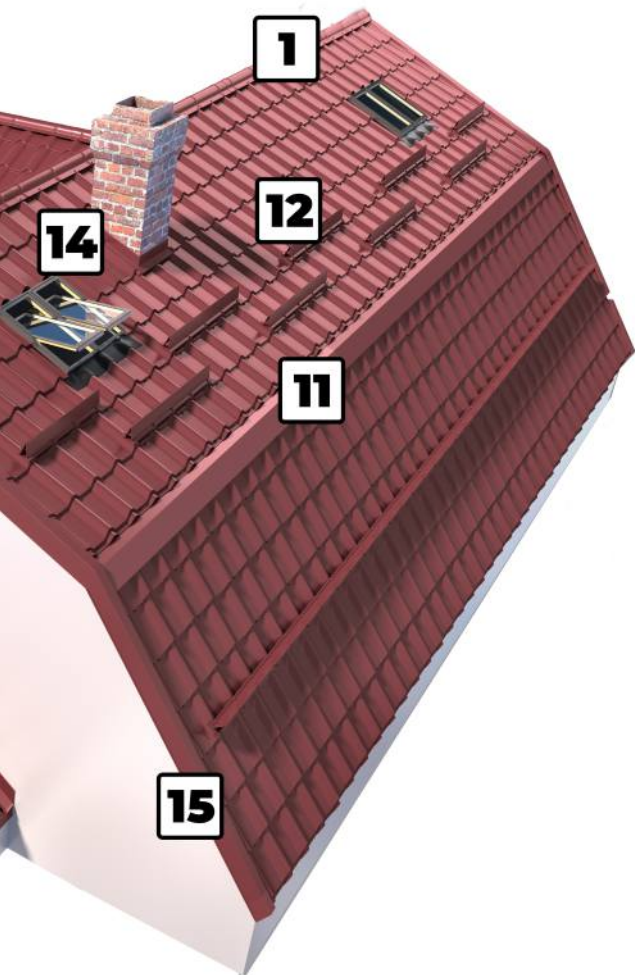

# (RETRO PANEL)

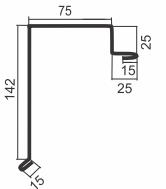
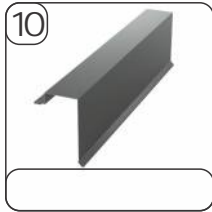
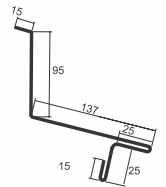
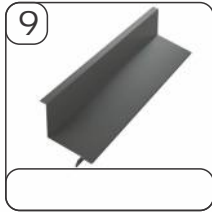
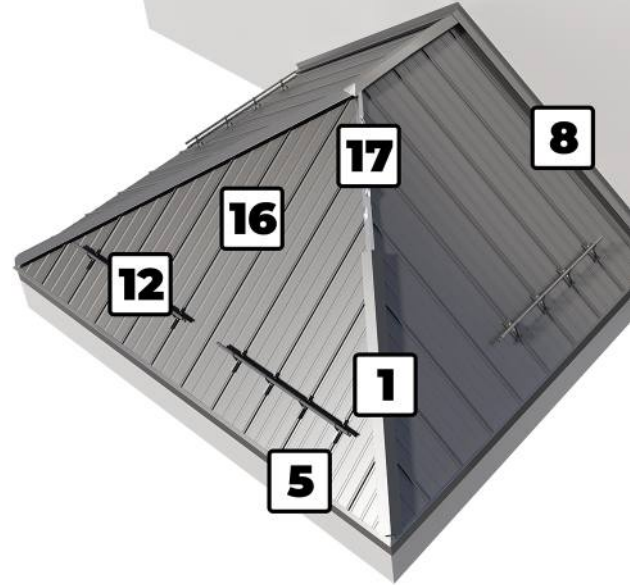
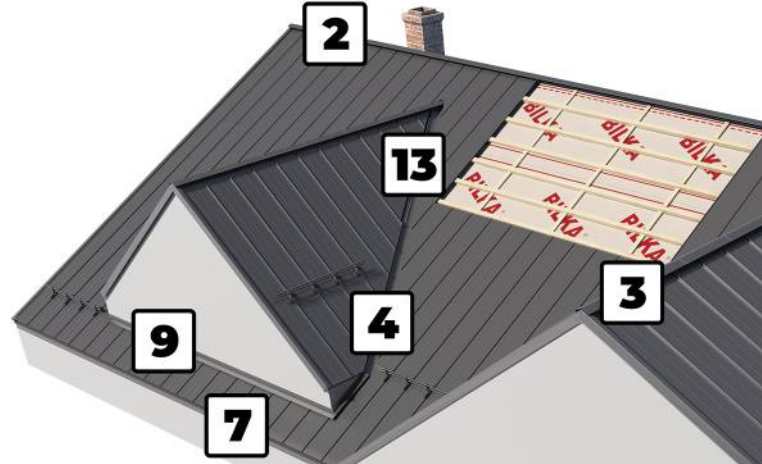
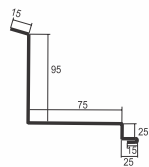
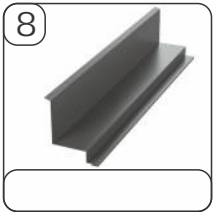
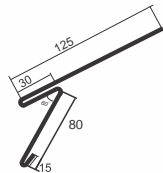
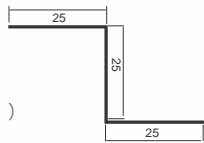
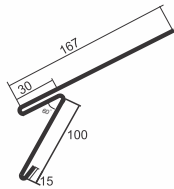
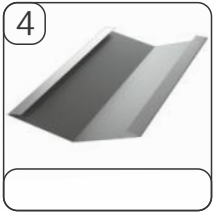
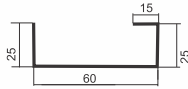
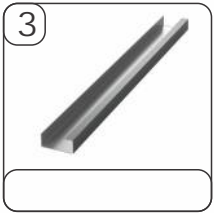
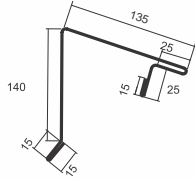
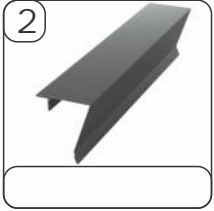
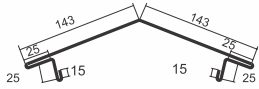
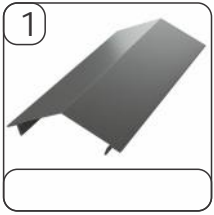

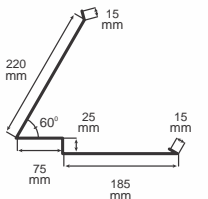
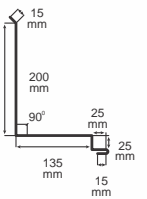
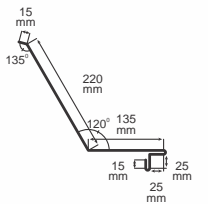
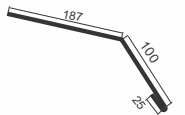
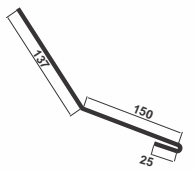
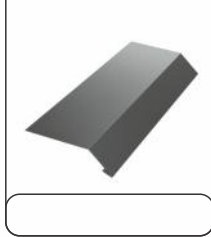
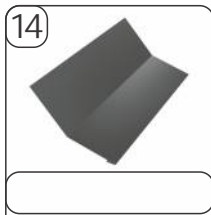
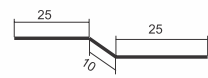
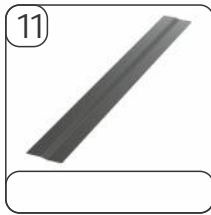

E

BILKA:

BILKA 95

	95 / 2	170 N/5 / 100 N/5	W 1, Sd 0,05

BILKA 120

25

	120 / 2 ± 10%	190 N/5 (±20%) / 160 N/5 (±20%)	+70 C	W 1, Sd 0,05 (±) 0,015

BILKA 140

	140 / 2 ± 5%	240 N/5 (±20%) / 200 N / (±20%)	+70 C	W 1, Sd 0,05 (±) 0,01

BILKA 150

	150 / 2 ± 5%	260 N/5 (-65; +25) / 130 N/5 (-30; +15)	+70 C	W 1, Sd 0,05 (±) 0,01

BILKA 180

BILKA 180 -

BILKA 180

	180 / 2 ± 10%	240 N/5 (+40; -50) / 140 N/5 (+35; -35)	+80 C; -30 C	W 1, Sd 0,02 (0,01; +0,04)

BILKA AntiDrop 100

BILKA AntiDrop 100

				Sd	
	100 / 2	120 /50 / 120 /50	110 / 110	W1 Sd 8 (+2;-2)	4

BILKA ALU 90

BILKA ALU 90

BILKA ALU 90

	90 / 2 ± 10%	100N	-30; 70 C
			Sd 50 ± 30%

BILKA ALU 150

BILKA ALU 150

BILKA ALU 150

	150 / 2 ± 10%	150N	-30; 70 C

BILKA

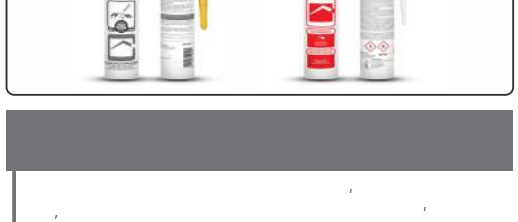
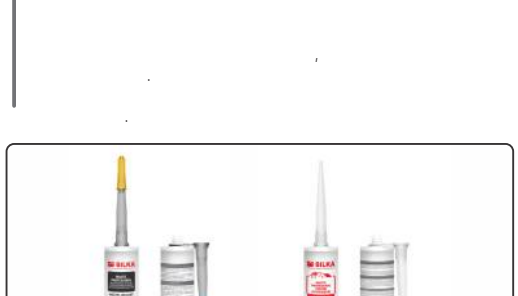
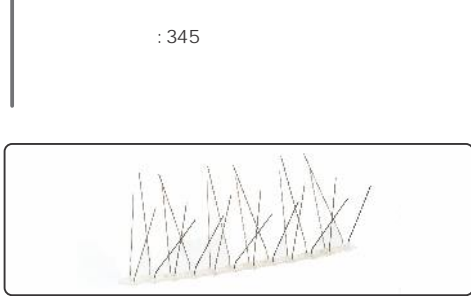
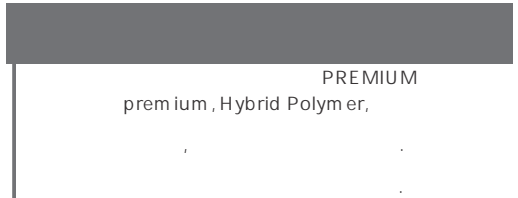
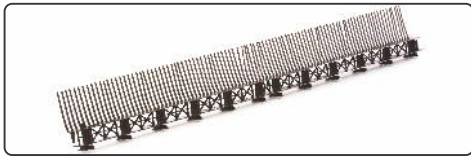
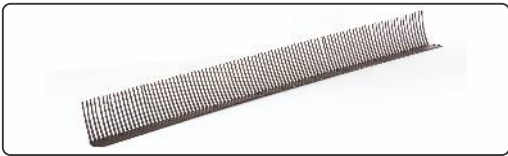

(D x L )	( )	( )	( )
4,8x19	3	8	
4,8x35	1,25	8	
4,8x25	1,25	8	
4,8x55	1,25	8	
4,8x70	1,25	8	
4,8x20	3	8	
5,5x25	5	8	
5,5x38	12	8	
5,5x60, 5,5x80, 5,5x100, 5,5x120	5	8	
5,5x140, 5,5x170, 5,5x90, 5,5x110, 5,5x130, 5,5x150, 5,5x190, 5,5x220, 5,5x250	12	8	

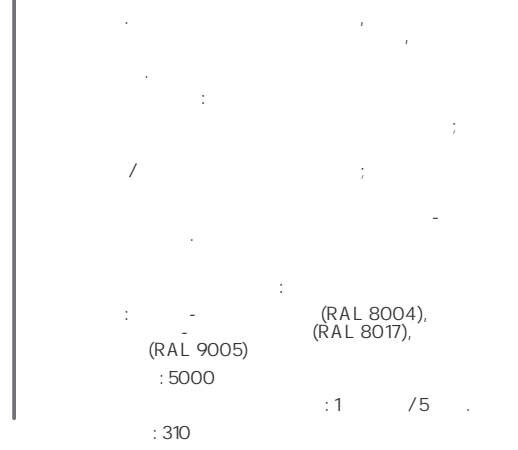



- 1.
- 2.
- 3.
- 4.
- 5.

45

10

1. Bilka

2. BILKA

3.

4.

**ГАРАНТІЙНИЙ СЕРТИФІКАТ**

UA-BLK 00001

Компанія **BILKA STEEL** гарантує, що зазначена в цьому сертифікаті продукція виготовлена і сертифікована виробником відповідно до діючих стандартів і параметрів і відповідає європейським стандартам.

Гарантія надається відповідно до Закону 449/2003.

Компанія **BILKA STEEL** надає таку гарантію на **НЕЗМІННІСТЬ КОЛЬОРУ** і **ВІДСУТНІСТЬ КОРОЗІЇ**



На водостічну систему/ для профнастилу з **Підфарбована**



для профнастилу з **Глянсовий/содіблений**



для профнастилу з **Матовим/Wood**



**ПРАВИЛА ТА УМОВИ ГАРАНТІЇ**

Гарантія надається на вироби, що поставляються компанією **BILKA STEEL**. Компанія **BILKA STEEL** несе відповідальність за прями або непрямі збитки, що виникли внаслідок такої бездіяльності:

• пошкодження внаслідок хімічного впливу агресивного оточення або в результаті впливу інших матеріалів, такими як рухлива бетонна суміш, мідь, цементний розчин, цегла тощо;

• механічних або інших пошкоджень внаслідок неправильного транспортування, бергівня (за винятком випадків, коли компанія **BILKA STEEL** бере на себе такі пошкодження);

• обробки продукції компанії **BILKA STEEL** піддавалася операціям різання за межів кругів або іншого різального інструмента, що призвело до локального злових виробів;

• **BILKA STEEL** піддавалася операціям машинної обробки при робочій температурі (на звичайній);

• **BILKA STEEL** піддавалася операціям машинної обробки при робочій температурі (у зимовий період);

• внаслідок уникнути прямого контакту продукції з рухливою бетонною сумішшю.

BILKA STEEL

BILKA STEEL

( BILKA STEEL BILKA STEEL )

) BILKA STEEL -10 ( )  
) BILKA STEEL +5 ( )

BILKA STEEL

45

BILKA STEEL,

BILKA STEEL



залежності від конкретних характеристик, але не більше 15 днів відповідно до положень, викладених у статті 11 Закону № 449/2003. Для цього замовник повинен надати представникам компанії **BILKA STEEL** доступ до цієї продукції з метою перевірки і можливого проведення ремонтних робіт.



Copyright © 2020 Bilka v.01

стор. 1

Рахунок-фактура

Прізвище/назва .....  
 Адреса .....  
 ІПН .....  
 Рахунок-фактура .....  
**ГАРАНТІЇ:**  
 Прізвище/назва .....  
 Адреса .....  
 Адреса доставки .....  
 ІПН/персональний код .....  
 Рахунок-фактура .....  
 Copyright © 2020 Bilka v.01

стор. 2

